



Luminares Contemporains

## Collection Office

PISTYLE - Design : Davide Oppizzi



# Choose your leaves and cords

## Feuilles et fils leaves and cords

Violet/vert - fil violet  
purple/green - purple cord

Bleu/jaune - fil bleu  
blue/yellow - blue cord

Vert - fil vert  
green - green cord

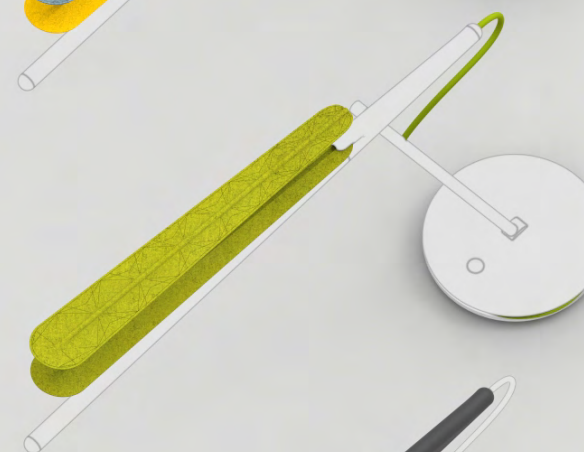
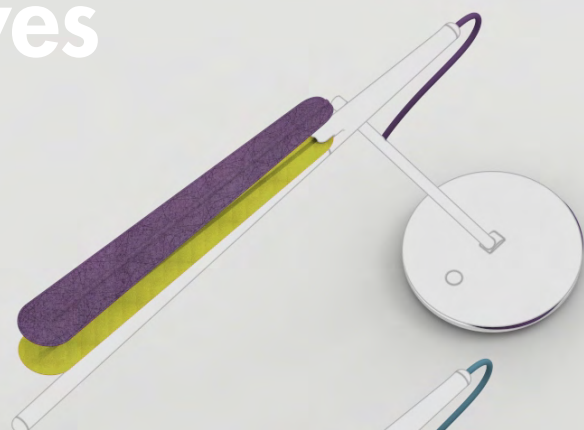

# Choose your body

## Pied body

gris anthracite  
anthracite grey

blanc  
white

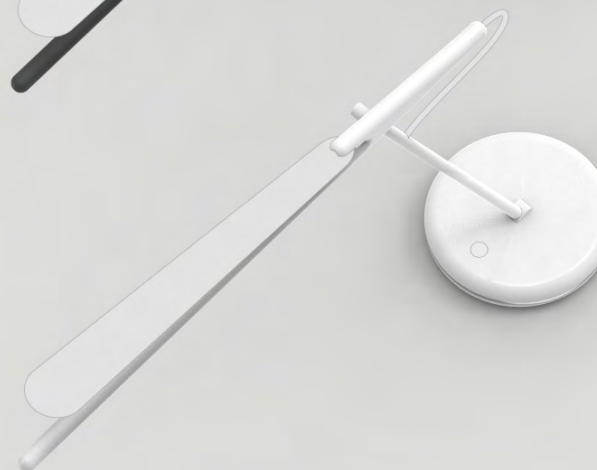
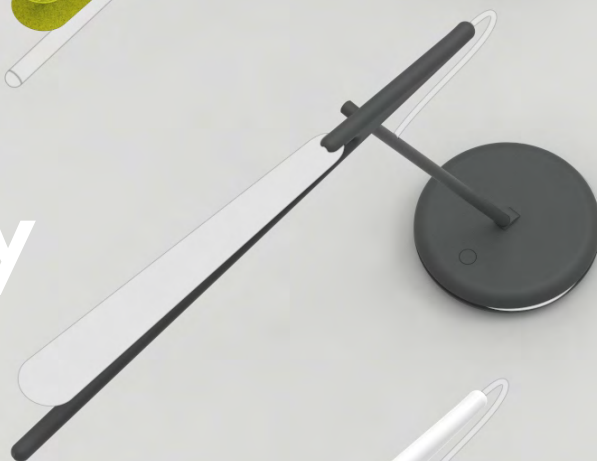

**Pistyle,**

**La nature s'invite dans nos bureaux.**

**Nature is invited in our offices.**



# Lampe de bureau Pistyle

## Pistyle desk lamp

Design Davide Oppizzi

Cette lampe versatile offre 3 axes rotatifs dont une orientation de la lumière à 360 degrés. Enfin une vraie lampe technique LED avec une dimension humaine, naturelle et décorative pour nos bureaux !

**Position 1** : elle éclaire la table dans une configuration perpendiculaire avec le LED orienté au choix vers la surface de la table ou en rétroéclairage de la feuille en laine feutrée.

**Position 2** : la lampe se dresse dans une position verticale et devient roseau décoratif à combiner avec différents coloris au centre d'un pôle de plusieurs tables.

**Position 3** : Son pied articulé permet d'incliner la lampe en allongeant son flux lumineux tout en gardant l'horizontalité de la source.

This versatile lamp offers 3 rotary axes including a light orientation at 360 degree. At last a real technical LED lamp with a livable, natural and decorative dimension for our offices !

**Position 1**: it illuminates the table in a perpendicular configuration with the LED facing either to the surface of the table or backlighting on the felted wool leaf.

**Position 2** : the lamp stands in an upright position and becomes decorative reed to combine with different colors in the center of a cluster of several tables.

**Position 3** : The articulated foot can tilt the lamp lengthening its luminous flux while keeping the horizontality of the source.

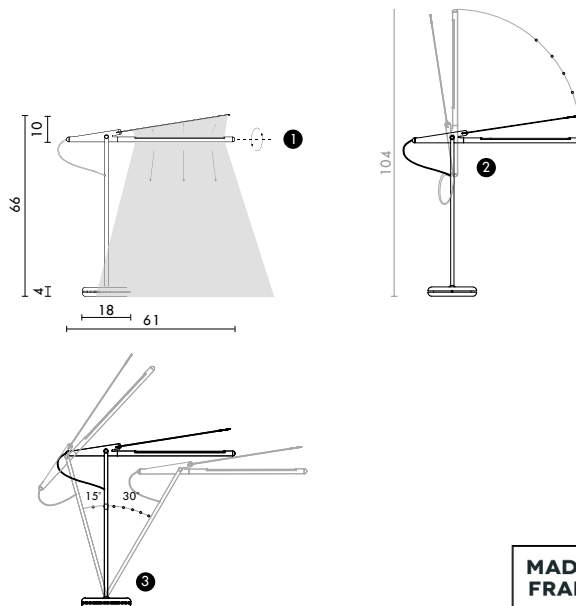

Lampe à poser L. 61 x l. 18 x H. 66 cm - Fil textile/Textile cord 2 m  
Pistyle 8 W - 230 V/120 V - 3000 K - IRC > 85  
Variateur tactile/Dimmer touch button  
Ref : Lbpi

LED CE RoHS IP20

Coloris/ Colors	Pied et corps : blanc ou gris anthracite Feuilles et fils : Vert - fil vert ; Bleu/jaune - fil bleu ; Violet/vert - fil violet. Base and body : white or anthracite grey Lightweight felt leaves and cords : green - green cord ; blue/yellow - blue cord ; purple/green - purple cord.
Matériaux/ Materials	Aluminium, laine feutrée, fil textile. Aluminum, lightweight felt, textile cord.

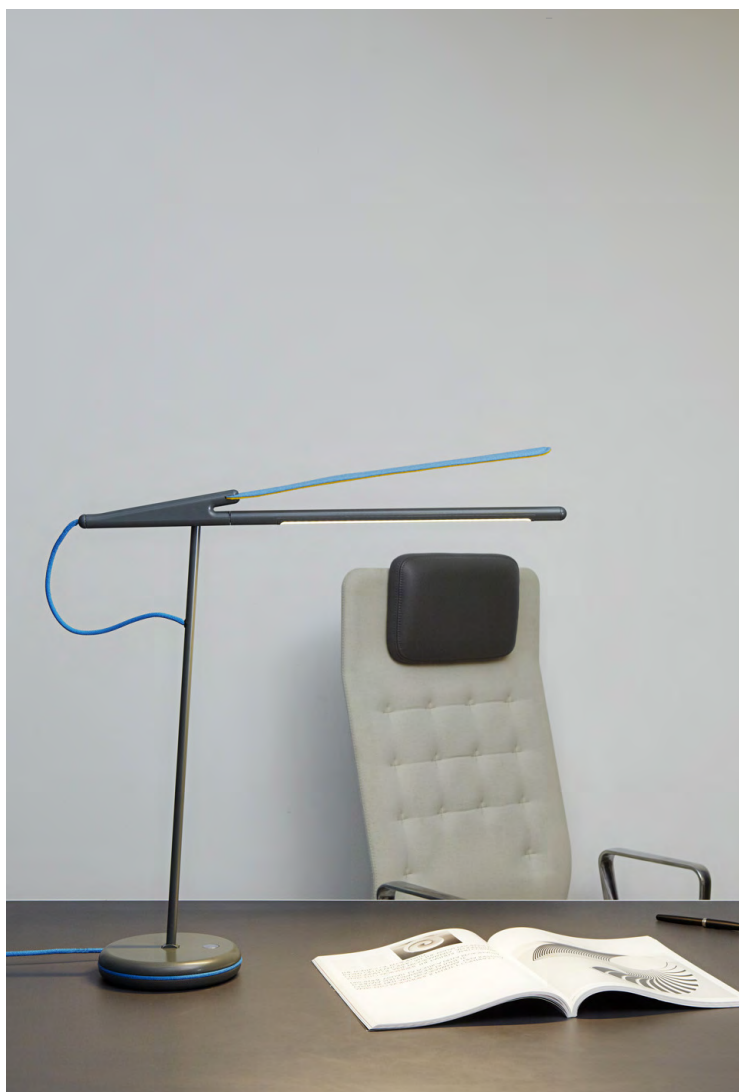

# Applique Pistyle

## Wall lamp Pistyle

Design Davide Oppizzi

L'applique Pistyle peut être installée dans deux positions :

- l'une en éclairage direct, la tige led orientée vers le mur, servant d'écran réflecteur ;
- l'autre en éclairage indirect vers la feuille en laine feutrée pour une lumière tamisée.

The wall lamp Pistyle can be installed in two positions:

- One in direct lighting, the LED rod facing the wall, serving as reflective screen ;
- Another in indirect lighting facing the lightweight felt for a soft light.

Applique Pistyle  
Position 1 : L. 28 x l. 8 x H. 61 cm  
Position 2 : L. 22 x l. 8 x H. 61 cm

Ref : Ampj  
Fil textile/Textile cord 0,3 m  
8 W - 230 V/120 V - 3000 K - IRC > 85

LED CE   

Coloris/  
Colors  
Pied et corps : blanc ou gris anthracite  
Feuilles et fils : Vert - fil vert ; Bleu/jaune - fil bleu ; Violet/vert - fil violet.  
Wall mount and body : white or anthracite grey  
Lightweight felt leaves and cords : green - green cord ; blue/ yellow - blue cord ; purple/green - purple cord.

Matériaux  
Materials  
Aluminium, acier, laine feutrée, fil textile.  
Aluminum, steel, lightweight felt, textile cord.

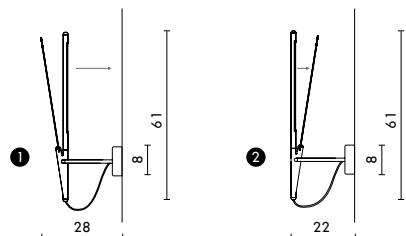

### 2 positions

① Éclairage direct  
Direct lighting

② Éclairage indirect  
Indirect lighting

## DESIGNER

### Davide Oppizzi

L'imagination de Davide Oppizzi, sa vision émotionnelle du monde matériel et immatériel, ainsi que son expertise dans des domaines « niches » le portent sur le devant de la scène internationale.

Des marques prestigieuses mondiales comme Chanel, Louis Vuitton ou Graff le mandatent pour créer des projets reflétant le lien profond entre l'être et la nature qui l'entoure, cette nature qui nourrit à tout instant ses inspirations.



Davide Oppizzi's imagination, his emotional vision of the material and immaterial world, as well as his expertise in the « niche » fields brings him on the international scene.

Prestigious worldwide brands, such as Chanel, Louis Vuitton or Graff, appointed him to create projects which reflect the deep link between the Human Being and the surrounding Nature, this Nature which feeds his inspiration at all times.



① Éclairage direct  
Direct lighting



② Éclairage indirect  
Indirect lighting

DESIGNHEURE SAS  
5, place Delille  
34200 Sète  
FRANCE

Tel : 33 (0)4 67 53 99 63  
contact@designheure.com

PRESSE  
Do it online : [www.b2p.fr](http://www.b2p.fr)  
sophie@b2p.fr  
Tel : 01.82.15.51.64

[www.designheure.com](http://www.designheure.com)

Made in France

